



www.sihga.com

# GoFix® MS II 6,0 / 8,0 / 10,0

INNOVATIVE BAUTECHNOLOGIE MIT SUPPORT FÜR DIE ZUKUNFT

MA Nr. 38812/24/7

TAKE THE BEST



**KLIMANEUTRALES  
UNTERNEHMEN**  
certified by Fokus Zukunft  
Klimaneutral durch Kompensation  
mit Klimaschutzzertifikaten



SIHGA® GmbH | Gewerbeplatz Kleinreith 4 | 4694 Ohtsdorf bei Gmunden | AUSTRIA  
Tel.: +43 7612 / 74 370 - 0 | E-Mail: info@sihga.com | [www.sihga.com](http://www.sihga.com)

## GoFix® MS II 6,0



## GoFix® MS II 8,0



## GoFix® MS II 10,0



SIHGAFIX®

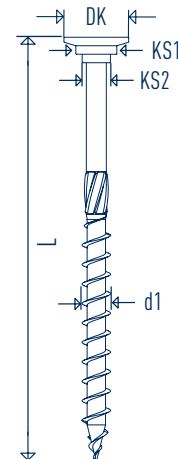
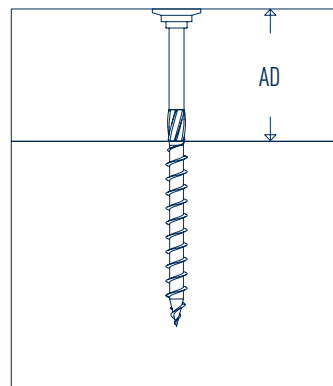

## GoFix® MS II 6,0

d1	L	TX	DK	KS1	KS2	AD
6,0	70	30	13,5	8,6	6,0	28
6,0	80	30	13,5	8,6	6,0	32
6,0	90	30	13,5	8,6	6,0	36
6,0	100	30	13,5	8,6	6,0	40
6,0	120	30	13,5	8,6	6,0	50
6,0	140	30	13,5	8,6	6,0	70
6,0	160	30	13,5	8,6	6,0	90
6,0	180	30	13,5	8,6	6,0	110
6,0	200	30	13,5	8,6	6,0	130

## GoFix® MS II 8,0

d1	L	TX	DK	KS1	KS2	AD
8,0	80	40	18,3	11,6	8	30
8,0	100	40	18,3	11,6	8	40
8,0	120	40	18,3	11,6	8	50
8,0	140	40	18,3	11,6	8	60
8,0	160	40	18,3	11,6	8	70
8,0	180	40	18,3	11,6	8	80
8,0	200	40	18,3	11,6	8	100
8,0	220	40	18,3	11,6	8	120
8,0	240	40	18,3	11,6	8	140
8,0	260	40	18,3	11,6	8	160

> 8,0 x 260 >>

## GoFix® MS II 8,0

d1	L	TX	DK	KS1	KS2	AD
8,0	280	40	18,3	11,6	8	180
8,0	300	40	18,3	11,6	8	200
8,0	320	40	18,3	11,6	8	220
8,0	340	40	18,3	11,6	8	240
8,0	360	40	18,3	11,6	8	260
8,0	380	40	18,3	11,6	8	280
8,0	400	40	18,3	11,6	8	300
8,0	450	40	18,3	11,6	8	350
8,0	500	40	18,3	11,6	8	400

## GoFix® MS II 10,0

d1	L	TX	DK	KS1	KS2	AD
10,0	80	50	22,5	14,4	10	30
10,0	100	50	22,5	14,4	10	40
10,0	120	50	22,5	14,4	10	50
10,0	140	50	22,5	14,4	10	60
10,0	160	50	22,5	14,4	10	70
10,0	180	50	22,5	14,4	10	80
10,0	200	50	22,5	14,4	10	100
10,0	220	50	22,5	14,4	10	120
10,0	240	50	22,5	14,4	10	140

> 10,0 x 240 >>

### GoFix® MS II 10,0

d1	L	TX	DK	KS1	KS2	AD
10,0	260	50	22,5	14,4	10	160
10,0	280	50	22,5	14,4	10	180
10,0	300	50	22,5	14,4	10	200
10,0	320	50	22,5	14,4	10	220
10,0	340	50	22,5	14,4	10	240
10,0	360	50	22,5	14,4	10	260
10,0	400	50	22,5	14,4	10	300
10,0	450	50	22,5	14,4	10	350
10,0	500	50	22,5	14,4	10	400
10,0	550	50	22,5	14,4	10	450
10,0	600	50	22,5	14,4	10	500

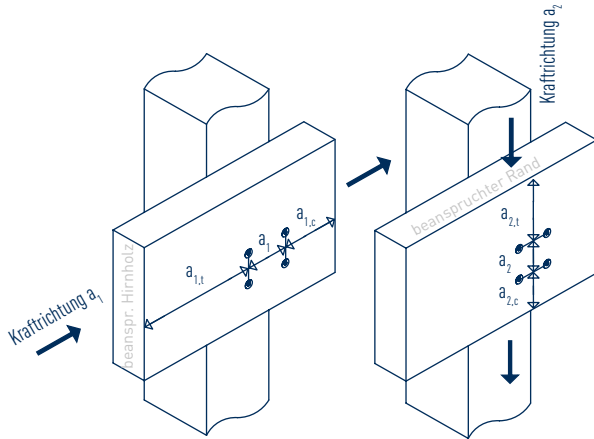
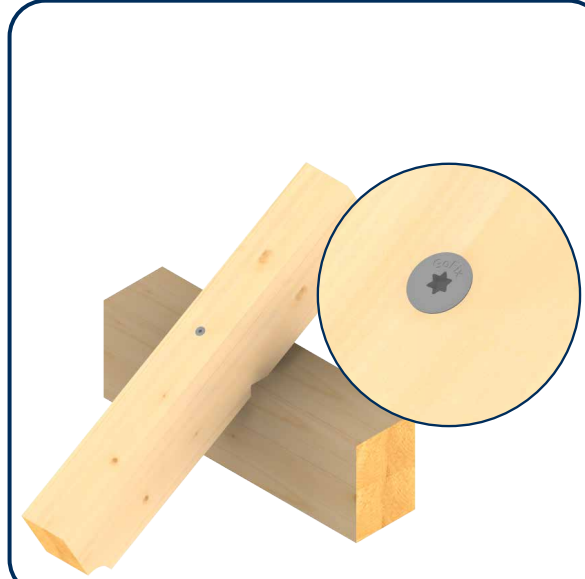
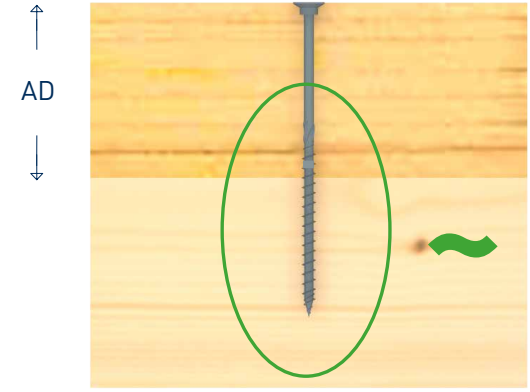
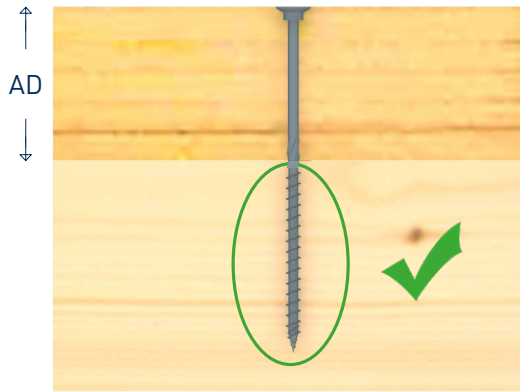
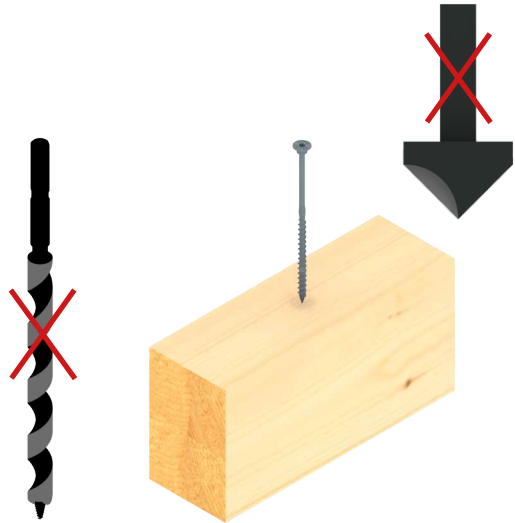

Achs- Randabstand	Abstand a	nicht vorgebohrt [mm]	vorgebohrt/Bohrspitze [mm]
$a_1$	parallel zur Faser	12 d	5 d
$a_{1,t}$	beanspruchtes Hirnholz	15 d	12 d
$a_{1,c}$	unbeanspruchtes Hirnholz	10 d	7 d
$a_2$	rechtwinkelig zur Faser	5 d	4 d
$a_{2,t}$	beanspruchter Rand	10 d	7 d
$a_{2,r}$	unbeanspruchter Rand	5 d	3 d

d... Schraubendurchmesser

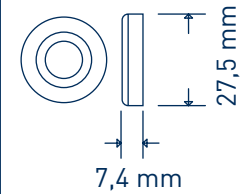

GoFix® MSZ

